

MEASUREMENT DIAGRAM

PLACEMENT - OUTER ALUMINIUM POSTS

OUTER CORNER

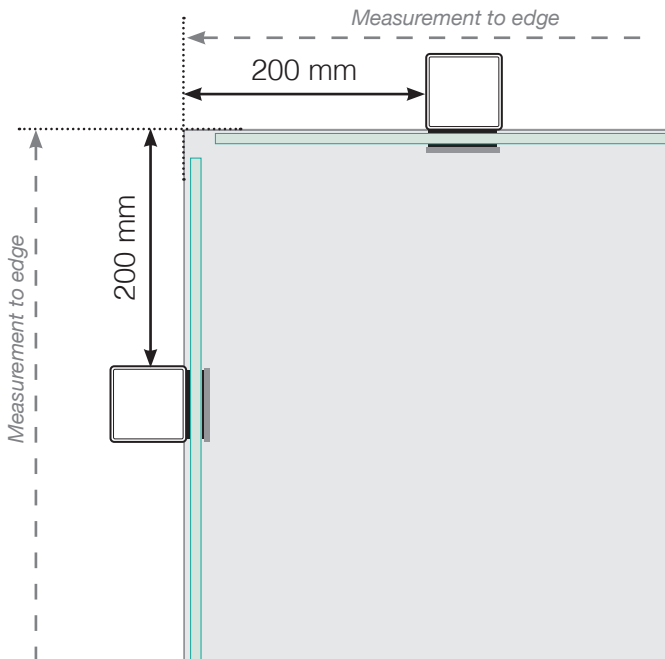

OUTER CORNER NOT 90°

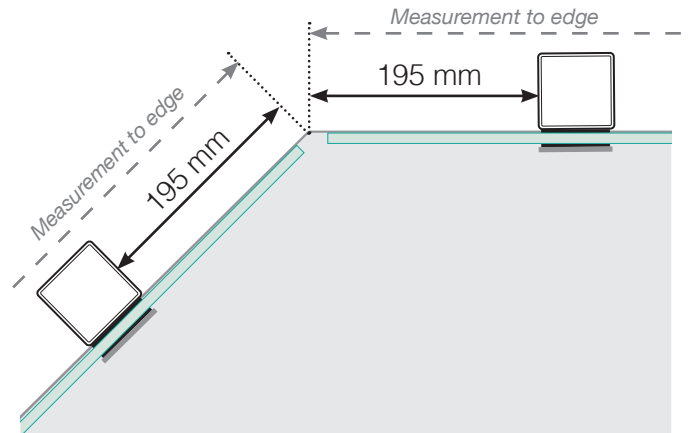

INNER CORNER NOT 90°

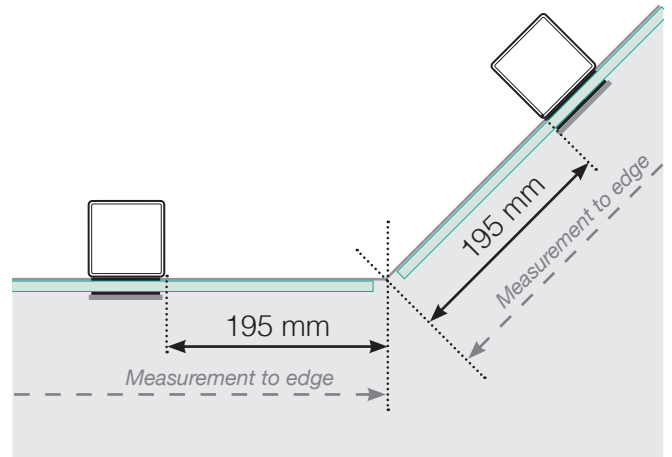

INNER CORNER

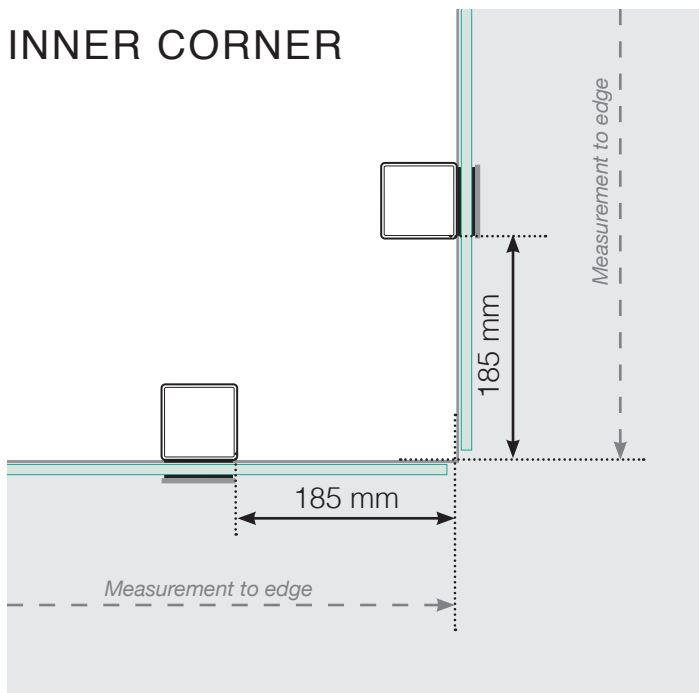

END

Free-standing

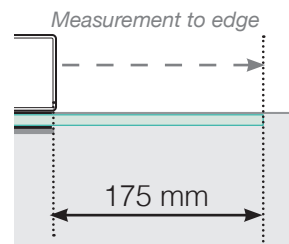

By the wall

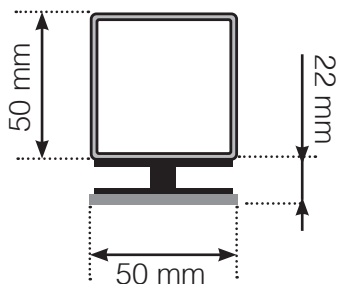
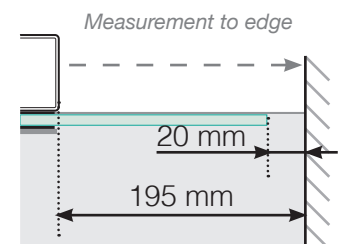

DISTANCE BETWEEN STRAIGHT SECTIONS

